

**F151**

**UMTS 850MHz Mobile Phone**

**User Manual**

Edition: 1<sup>st</sup> edition, Dec., 2006

Copyright © 2006 by ZTE Corporation

All rights reserved.

No part of this publication may be excerpted, reproduced, translated or utilized in any form or by any means, electronic or mechanical, including photocopying and microfilm, without the prior written permission of ZTE Corporation.

ZTE Corporation operates a policy of continuous development. ZTE Corporation reserves the right to make changes and improvements to any of the products described in this document without prior notice.

### **PC Software Requirements**

The Join Me PC Software supports Windows 2000 with Service Pack 4 or Windows XP with Service Pack 2 only. Please install the CD before connecting your handset to your PC. See the Read Me file on the CD for full instructions.

# Contents

<b>1 For your safety</b> .....	<b>7</b>
General Safety .....	7
Hospital Safety .....	9
Efficient use .....	9
Radio Frequency Energy .....	10
Emergency Services .....	10
Declaration of Conformity .....	11
Copyright Notice .....	11
Limited Warranty .....	12
Limitation of Liability .....	12
<b>2 Getting Started</b> .....	<b>13</b>
Overview .....	13
Key Definition .....	14
Display Symbols .....	17
Installing the USIM Card .....	18
Battery Installation, Charging and Care .....	19
Powering Your Phone On and Off .....	23
<b>3 Basic Operation</b> .....	<b>24</b>
Making a Voice Call .....	24
Making a Call from Contacts .....	25
Receiving a Voice Call .....	25
General Navigation .....	28

<b>4 Tools (Shortcut = Menu, 1)</b> .....	<b>29</b>
File Manager.....	29
Photos .....	30
Audios .....	31
Videos .....	32
Others .....	33
Time.....	34
Alarm.....	34
Calendar.....	35
Stopwatch.....	36
Calculator .....	36
Currency Conversion .....	37
World Time.....	37
<b>5 Messages (Menu, 2)</b> .....	<b>38</b>
Create a New SMS Message.....	38
Create a New Multimedia Message .....	39
Inbox.....	40
Outbox.....	40
Drafts .....	41
Sent .....	41
User folders .....	41
(U)SIM box .....	41
Multimedia Message Settings .....	42
Text Message Settings.....	43
Templates Settings .....	43
Memory info.....	43
E-mail .....	44

<b>6 Games &amp; Applications (Menu, 3)</b> .....	<b>45</b>
Applications .....	45
Settings.....	45
<b>7 Contacts (Menu, 4)</b> .....	<b>46</b>
All Records .....	46
Groups.....	47
Create New Contact.....	47
Copy Contacts from USIM Card to Phone.....	48
<b>8 Telstra Services (Menu, 5)</b> .....	<b>49</b>
<b>9 Calls (Menu, 6)</b> .....	<b>51</b>
Call log.....	51
Calls info.....	51
<b>10 Settings (Menu, 7)</b> .....	<b>52</b>
Screen .....	52
Handset .....	53
Profiles.....	54
Security.....	55
Call .....	56
Call Divert.....	56
Call Waiting .....	57
Call Barring.....	57
Send my number .....	58
Any Key to Answer .....	58
<b>11 Multimedia (Menu, 8)</b> .....	<b>59</b>

Media player .....	59
Favorites .....	60
<b>12 Browser (Menu, 9).....</b>	<b>62</b>
Home .....	62
Go to.....	62
Bookmarks.....	63
History .....	63
Page memo .....	63
Push messages .....	64
Options .....	64
<b>13 Text Input .....</b>	<b>65</b>
ABC and abc mode.....	65
123 mode.....	65
Predictive Text (En).....	66
Special Characters.....	66
<b>14 Troubleshooting .....</b>	<b>68</b>
<b>15 Glossary .....</b>	<b>69</b>
<b>16 Technical Parameters .....</b>	<b>70</b>
<b>17 Environmental Statement.....</b>	<b>72</b>

# 1 For your safety

## General Safety

The handset contains delicate electronic circuitry, magnets and battery systems. You should treat it with care and pay attention to the following points:

- Do not allow the handset, battery or accessories to come into contact with liquids or condensing moisture at any time. Do not immerse in any liquid.
- Do not leave the handset or battery in direct sunlight or near other heat sources where the temperature could exceed 60 °C
- Take care not to allow metal objects, such as coins or key rings, to come into contact with the battery terminals.
- Do not put the battery in your mouth.
- Only use original replacement batteries from your dealer.
- Do not place the handset near computer disks, credit cards, and other magnetic media. The information contained on disks or cards may be erased or damaged.
- Keep the handset, battery, charger and any other accessories away from children.
- Do not dispose of battery packs in a fire. The handset's Li-ion batteries may be safely disposed of at a Li-ion recycling point.
- Do not attempt to dismantle the handset or any of its accessories.
- Do not place the handset close to the edge of a table in case it moves when set on vibration mode.

- Do not put the handset into a microwave oven, dryer, or high-pressure container.
- Be careful not to pierce the battery with sharp objects and do not use a battery that is damaged in any way.
- Do not disassemble or modify the battery.
- Stop using the battery if abnormal heat, odour, discolouration, deformation, or abnormal condition is detected during use, charge, or storage.
- Remove the battery at the end of its life and dispose of safely.
- Observe and obey warning signs at petrol stations, airports and hospitals.
- Do not leave your handset at the bottom of a bag where it may be damaged by excessive weight or sharp objects.
- Do not connect the handset to any other chargers or cigarette lighter chargers. Only use the supplied charger.
- When the battery is thrown away cover the terminals with insulating tape. Please recycle (see last page).
- Do not drop, throw, or subject the handset to rough treatment.
- In the unlikely event of a battery leak, take care to keep the battery discharge away from your eyes or skin. In the event of contact please flush thoroughly with clean water and consult a doctor.
- It is normal for the handset to become warm while the battery is being charged.
- Do not use the handset where blasting is in progress.
- Take care not to put your phone in your back pocket and then sit on it.



- Do not leave the handset discharged or disconnected for a long time, otherwise your personal data may be lost.
- Do not use your handset while driving or operating other machinery.
- Remember to make backup copies of all important data on your handset.
- Please recycle the packaging.

## Hospital Safety

- Switch your phone off in areas where the use of handsets is prohibited. Always obey the warning signs and follow the instructions given.
- The operation of some medical electronic devices, such as hearing aides and pacemakers, may be affected by the handset. Observe and obey all warning signs.

## Efficient use



The handset has an internal antenna located at the top of the phone. For optimum performance with minimum power consumption do not cover the antenna area with your hand. Covering the antenna affects call quality, may cause the handset to operate at higher power level than needed, and may shorten talk and idle times.

## Radio Frequency Energy

Your handset is a low-power radio transmitter and receiver. When switched on it intermittently transmits radio frequency (RF) energy (radio waves). The transmit power level is optimized for best performance and automatically reduces when there is good quality reception. Maximum power is only used at the edge of network coverage, so under most circumstances the power output is very low.

## Emergency Services

### **To make an emergency call in any country:**

- 1 Ensure that your handset is switched on and in service.
- 2 Press  key as many times as needed to clear the display and return to the idle screen.
- 3 Enter the emergency number for your present location using the keypad. (eg 000 or 112)
- 4 Press  key to call the number. Follow instructions received and do not end the call until told to do so.

## To make an emergency call without a USIM card

When the USIM card is not inserted enter the emergency number and press  or OK key to make the call.

You can also activate the emergency call with a single key-press by pressing the **SOS** soft key button.

### Note:

- Tell the operator which service you require. Give your position and, if possible, remain stationary to maintain best contact.
- Due to the nature and coverage of the cellular system the connection of emergency calls cannot be guaranteed. You should never rely solely on any wireless device for essential communications like medical emergencies.

## Declaration of Conformity

We declare under our sole responsibility that the product(s) detailed in this manual, and in combination with our accessories, conform with the essential requirements of The Radio Communications Standard (Electro-magnetic Radiation Human Exposure) 2003 and the Australian Communications and Media Authority Section 376 of the Telecommunications Act 1997. The Product is compliant with IMEI INTEGRITY requirements as defined in GSM standards:2.07/02.09/02.16/02.30/03.0304.08, 3GPP standard:22.016/23.003

## Copyright Notice

The video/audio recordings you transfer or download may be protected by copyright laws. They are for personal use only and must not be otherwise used without the permission of the copyright owner.

## Limited Warranty

The warranty does not apply to defects or errors in the product caused by:

- (a) Reasonable abrasion
- (b) Misuse including mishandling, physical damage, improper installation, unauthorized disassembly of the product
- (c) Water or any other liquid damage
- (d) Any unauthorized repair or modification
- (e) Power surges, lightning damage, fire, flood or other events outside ZTE's reasonable control
- (f) Use of the product with any unauthorized third party products such as generic chargers
- (g) Any other cause beyond the range of normal usage for Products.

The End User shall have no right to reject, return, or receive a refund for any Product from ZTE under the above-mentioned situations.

## Limitation of Liability

ZTE shall not be liable for any loss of profits or indirect, special, incidental or consequential damages resulting from or arising out of or in connection with using this product, whether or not ZTE had been advised, knew or should have known the possibility of such damages.

The user should refer to the enclosed warranty card for full warranty and service information.

## 2 Getting Started

### Overview

Thank you for purchasing the F151 UMTS Mobile Phone. The F151 is capable of operating in UMTS (Universal Mobile Telecommunication System) mode, also known as 3G, GSM (Global System for Mobile Communications) or 2G, and

# Key Definition





### **Left select key**

Execute prompts that appear at the lower left corner of the screen. Shortcut to **Contacts**.



### **Right select key**

Execute prompts that appear at the lower right corner of the screen. Shortcut to Telstra Business web site (BIZ)



### **Call key**

Make and answer calls. Show **All calls** logs in idle state.



### **End key**

End a call, reject a call, exit applications. Power on/off – hold for 4 seconds.



### **Clear key**

Delete characters when editing.



### **Back key**

Returns you to the previous screen.

**Up:** Scroll up. Shortcut to **My Place**. Move cursor to previous field.

**Down:** Scroll down. Shortcut to **Contacts**. Move cursor to next field.

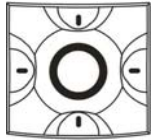

**Left:** Scroll left. Shortcut to **Calendar**. Move left on tabs.

**Right:** Scroll right. Shortcut to **Multimedia**. Move right on tabs.

**OK key:** Confirm actions, make selections. Execute prompts that appear in the lower middle of the screen.

### **0~9 Number key**



Dial numbers. Enter numbers and characters. Press and hold for speed dialing. Select items on menu lists. Shortcut to functions through the menu system.

Long press (press and hold) on **Key 1** goes direct to **Voicemail** (#101#)

**# key:** Switch between different text input modes: Predictive Text, ABC, abc or 123

















Long press to activate key lock. Press and hold the # key then follow the prompts



**\* key:** Enter symbols mode when editing. In idle states press twice for + symbol for international dialing prefix.



# Display Symbols

	Signal Strength of the GPRS Network		Alarm
	Signal Strength of the 3G Network		Battery Level Indicator
	No signal		Missed Call
	New Message		Call Forward (All Calls) is Active
	New E-mail		Silent Mode
	New Wap Push Message		Vibration Mode
	Message Memory is Full		Headset Mode
	E-mail Memory is Full		Headset and Vibration Mode
	Wap Push Message Memory is Full		GPRS Attach
	Roaming		PDP Context Established

## Installing the USIM Card

The USIM card stores your network connection authority, service details, phonebook and text messages. It must be inserted into your phone prior to use.

First disconnect the charger and other accessories. Remove the back panel and the battery (as described below).

Handle the USIM card with care and avoid static electricity and magnetism. Do not bend or scratch your USIM card.

If the USIM card is removed or damaged then the handset becomes unusable except for emergency calls.

The USIM card is installed in a holder underneath the battery. Insert the card into the holder as shown with the gold contacts on the USIM card facing down and the beveled corner facing to the top left. Ensure the USIM card is pushed all the way to the base of the phone.

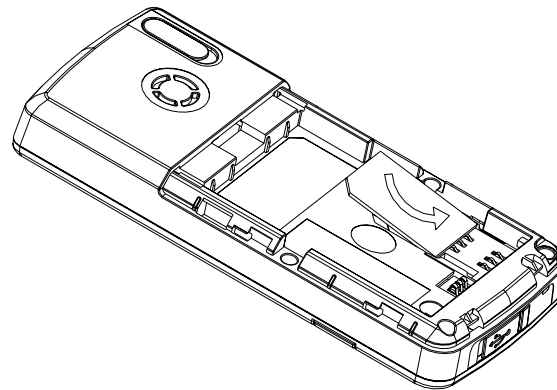

# Battery Installation, Charging and Care

## 1. Removing the Battery

Switch off the handset. Find and press the release button in the upper middle of the back panel and gently slide the panel down to reveal the battery compartment. Find the groove on the top of the battery and lift the battery up and out.

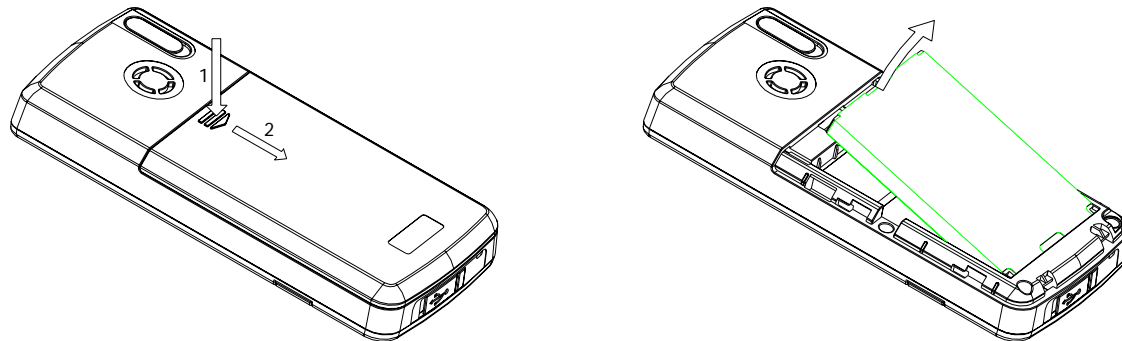

## 2. Installing the Battery

Locate the contacts on the battery. Insert the battery so the contacts line up with the terminals on the phone. The battery can only be inserted one way. Replace the back cover by locating the cover **flat** within 5mm of the closed position and *slide* the cover up to lock it. Do not force the cover down at an angle as this will damage the lugs.

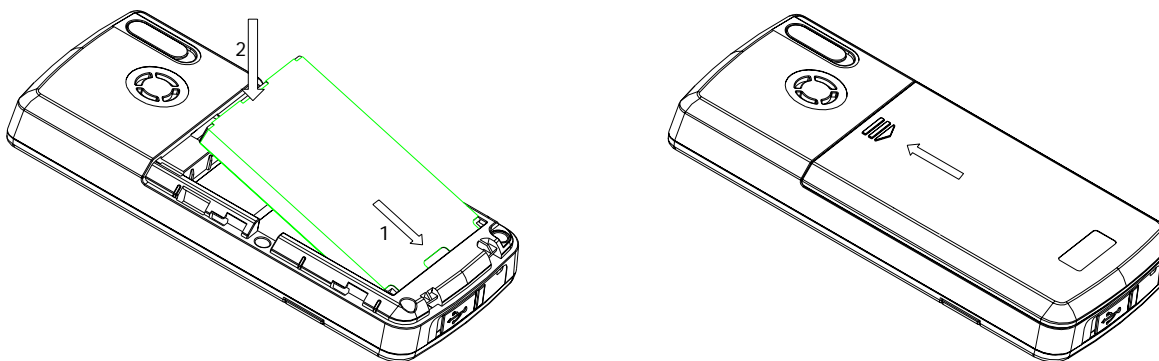

The battery is not fully charged when you buy your phone but there may be enough power in the battery to turn the phone on. A battery that has not been used for a long period of time needs to be completely discharged and then recharged two or three times before reaching full capacity.

**Note:**

- The F151 automatically switches off if the battery voltage is too low.
- Batteries have a limited life span. If the battery does not last as long as it used to, the battery may be coming to the end of its life. Replace the battery with a new one of the same type.
- When not using the battery for a long period remove it from the F151 and store it in a cool dry place.
- Do not leave the phone connected to the charger for extended periods of time eg > 24 hrs.

### 3. Charging the battery

- Open the rubber port cover and connect the charger to the socket on the bottom of the phone.
- The charger plug will only fit one way into the phone.
- Connect the charger to a standard AC wall socket and switch on.
- The phone will show a charging animation on the display. If the phone is not used for a long time or the battery is completely flat it may take a few minutes before this indicator appears.
- When charging, ensure the power cable is kept clear of walkways and does not cause a hazard.

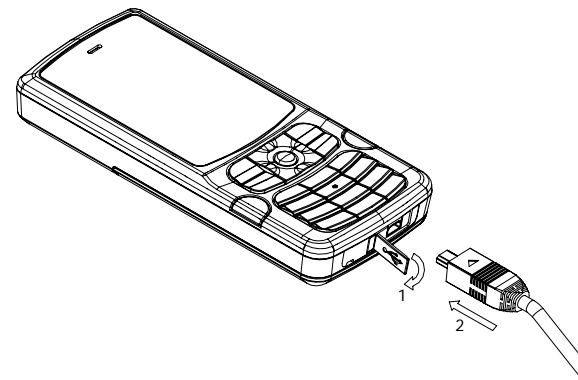

## 4. Battery Information and Care:

- Only use the supplied charger. Use of an unauthorized charger may damage the phone and invalidate the warranty.
- Charge the battery promptly when it is flat.
- Charge the battery between 0°C~50°C. If the temperature of the handset is too high, switch it off and let it cool.
- If the battery is not fully charged after 5 hours charging, please stop charging.
- Do not connect the battery directly to an electrical outlet or cigarette lighter charger.
- Stop using the battery if abnormal heat, odour, discolouration, deformation, or abnormal condition is detected during use, charge, or storage.
- Keep the battery's metal contacts clean.
- Do not leave a loose battery in your pocket or handbag where metal objects could short the terminals. This could be a fire or injury hazard.
- Battery life can be maximized by regularly allowing the phone to fully discharge before recharging the battery.
- When the battery voltage is low the phone will alert and may have limited functionality.

## Powering Your Phone On and Off

Ensure that your USIM card is fitted properly and the battery is charged. Press and hold the  key to power on the phone. The screen will display the following prompts in turn (depending on your security settings):

<b>Enter the unlock code</b>	If handset lock code has been activated.  The default password is 0000
<b>Enter PIN code</b>	As provided by Telstra.



Once the security conditions have been met and the USIM is correctly installed the handset will automatically register with the network and the network service provider's name or logo appears on the display.

See the chapter on **Settings – Security** for more details.

## 3 Basic Operation

### Making a Voice Call



1. Make sure your handset is on and connected to the network.
2. Enter the phone number using the keypad.
3. Press **Call key**  to make a voice call.
4. Press the **End Key**  to end the call.

### General Usage Notes

Use **clear key** to delete a digit or press and hold the **clear key** to delete all digits.

Use the arrow buttons (left, right, up, down) to edit the number or move the cursor.

To make an international call, press the **\* key** twice for the international prefix "+".



## Making a Call from Contacts

You can also make a call using a name in your Contacts.

1. Enter Contacts list, Scroll to a record or type the first few letters and select the correct contact name.
2. Press the **Call key** to make a voice call.
3. Press **End key** to end the call.

## Receiving a Voice Call

When you receive a call, the ring tone, illumination and vibrate function will activate (depending on your current profile setting).

1. Press **Call key** or **OK key** to answer an incoming call.

**Note:** When **Any key to answer** function is activated you can press any key except the **Left select key, Right select key, Back key** and **End key** to answer the call. With the headset is connected, pressing the headset switch will also answer the call.

2. Press **Right Select Key** or **End Key** to reject a call.

Press **Left Select Key** for further options during a voice call:

- **Hold**: Puts the current call on hold. You can then dial a third party independently and can switch between your two calls by pressing **Hold** again.
- **End call**: End current call.
- **DTMF Off/On**: Enable or disable sending DTMF tones.
- **SMS**: Switch to SMS interface during a call.
- **Contacts**: Switch to Contacts interface during a call.

3. Press **End Key** . The call is disconnected and the call duration is displayed.

**Notes:** The F151 supports multi-party conferencing depending on network support. Use **Left/Right Key** to toggle between connected parties.

## Useful Tips

Useful tips for receiving a call are shown below:

Operation	Procedure
Turning off the Ring tone	<ul style="list-style-type: none"><li>● When your phone is ringing, press <b>Left Select Key (Options)-Mute</b>.</li><li>● In idle state, select <b>Settings-Profiles-Edit-Ring volume-Silent</b>.</li></ul>
Rejecting a call	<ul style="list-style-type: none"><li>● Press <b>End Key</b>.</li><li>● Press <b>Right Select Key [Reject]</b>.</li></ul>
When you miss a call	<p>The Missed Call icon  will show in the idle state and the number will be saved to the <b>Missed calls</b> list.</p> <p>Press <b>OK Key</b> to view the details.</p> <p>Once you've viewed the Missed Call details, the icon disappears.</p>

# General Navigation

The normal background screen is called the idle screen. Press **OK** to access the main menu, the **Left Select Key** to access **Contacts** or the **Right Select Key** to access the **Telstra Business** web site, BIZ

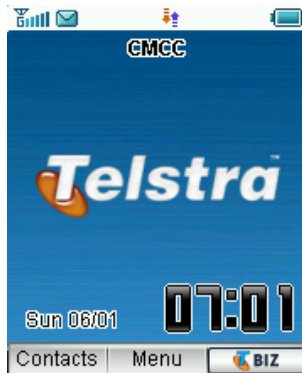

**Idle Screen**

Pressing the **Menu** button takes you to the **Main Menu**. Navigate round the main menu by using the arrow keys.



**Main Menu**

## 4 Tools (Shortcut = Menu, 1)



From the idle state press **Menu** →1, or move the cursor to select **Tools**.

## File Manager



Press **OK** to open **File Manager** which opens further menu choices of **Photos, Audios, Videos, and Others**.

# Photos

## Pictures

In this menu press **Connect** to connect to a web site to download pictures and ringtones.

## My Pictures

This application enables you to view still images. In the **My Pictures** folder, highlight the desired picture, press **OK key** to **Open** the image; press **Mark** to mark the file; Press **Options** to access submenu:

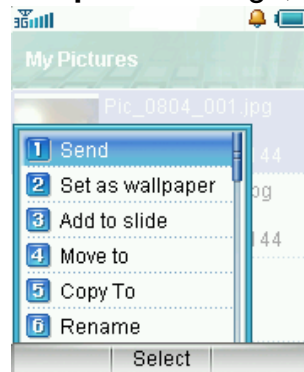

- **Send:** Send the image via MMS or E-mail.
  - **Set as wallpaper:** Set the picture as wallpaper.
  - **Add to slide:** Add this picture to the slide show.
  - **Move to:** Move the picture to another folder.
  - **Copy to:** Copy the picture to another folder.
  - **Rename:** Change the name of the picture.
  - **Delete:** Delete this picture.
- 
- **Delete all:** Delete all files in **My Picture** folder.
  - **Mark all files:** Mark all files in **My Picture** folder.
  - **File information:** Show information about the file size and created time.
  - **Space information:** Show the used space in each folder and the total available space.
  - **New folder:** Create a new folder in my picture folder.

## Wallpapers

In the wallpapers list, press **Open** to view the picture; press **Mark** to mark the file; press **Options** to enter the submenu. The submenu is similar to that of **My Pictures**.

## Audios

Select **Audios** to connect to a web site to download audio files.

## Ring

In the ring tones list, press **Open** to play the file, press **Mark** to mark the file; press **Options** to enter the submenu:

- **Send:** Send the file via MMS/E-mail.
- **Set as ring tone:** Set the file as your ring tone.
- **Add to playlist:** Add the file to the play list.
- **Mark all files:** Mark all files in the ring tones folder.
- **File information:** Show information about the file size and created time.
- **Space information:** Show the space information for each folder and total available space.

## My Audios

In file list press **OK Key** to play the selected files, press **Mark** to mark the highlighted file. Press **Options** to enter submenu. The submenu is similar to those above and contains options already discussed.

During playback, you can press **Mute** to mute the sound and use the **Up / Down** keys to adjust the volume.

## Videos

Select **Videos** to connect to a web site to download video files.



## My Videos

In my videos list press **OK key** to play the selected files, press **Mark** to mark a highlighted file. Press **Options** to display the following menu.

- **Send:** Send the file via MMS or E-mail.
- **Rename:** Rename the file.
- **Move to:** Move the file to another folder.
- **Copy to:** Copy the file to another folder.
- **Delete:** Delete the selected file.
- **Delete all:** Delete all the files in **My Videos** folder.
- **Mark all files:** Mark all video files.
- **File information:** Show information about the selected video file.
- **Space information:** Show the space information for each folder and total available space.
- **New folder:** Create a new video folder.

## Others

You can save other files here.

# Time

In the **Tools** menu you can scroll **Right** to select the **Time** tab to access the **Alarm**, **Calendar** and **Stopwatch** settings.

## Alarm

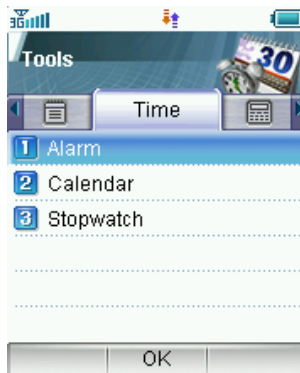

Press **Options** to display the following popup menu items:

- **Edit alarm:** Allows you to set the alarm type, date, time, ringtone and subject. Use **Up** and **Down** keys to navigate and **Left** and **Right** Keys to change the settings or edit. When complete press **OK key** to save.
- **Set rest days:** Press **Up/Down key** to highlight the day. Press **Select/Cancel** then **OK key** to change the rest day. The alarm type **Workday** will not ring on the

defined rest day(s).

- **Delete all:** Delete all the alarm settings.

**Note:** Schedules and Alarms still work when the handset is switched off.

## Calendar



The cursor appears on the current date. You can move the cursor to the desired location using the **Up/Down/Left/Right** keys. If any schedule or reminder is set, a small dot appears on the bottom right corner of the date.

1. Press **Add** to add a new schedule item.

Select schedule type, Subject, Start time, End time, date, Alarm set, etc. Press **Up/Down key** to select options, press **Left/Right key** to change. Press **OK key** to save.

2. Press **Open**→**View** to view the schedule item.

3. Press **Options** to display the following popup menu items:

- **Week view:** Enter weekly calendar.
- **Go to date:** View the date information.
- **Delete entry:** Delete schedule items.
- **Settings:** Settings for individual schedule item, such as alarm tone, default view etc.
- **Memory Info.:** Shows the current memory usage.

**Note:** Schedules and Alarms still work when the handset is switched off.

## Stopwatch



The phone has a built in stopwatch accessible through the **Tools** menu.

1. Press **OK key** to start timing.
2. Press **OK key** to stop timing. The screen will show the event time.
3. Press **OK key** to continue timing.
4. Press **Right select key** to reset.

## Calculator

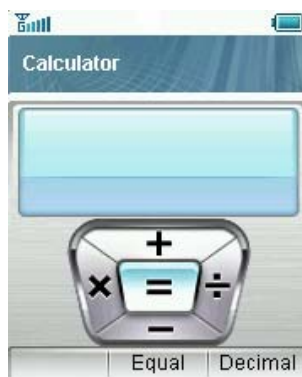

The phone provides a simple calculator accessible through the **Tools** menu.

1. Press **0~9 key** to enter numbers, **Decimal** to enter the decimal point.
2. Press **Up/Down/Left/Right key** to choose +, -, x, ÷.
3. Press **Clear key** to clear last digit and results.
4. Press **OK key** to get results. Press **End key** or **Back** to exit the calculator.

## Currency Conversion

This function allows you to quickly compare foreign currency to your local currency.

1. Press **Left select key** to input a currency exchange **Rate**. Press **Right select key** to input the decimal.
2. Enter **Foreign amount** or **Local amount** and the result is shown automatically.

## World Time

The world time function provides time information on major cities worldwide.



1. You can scroll to the desired city by using **Left/Right key**.
2. Press **Setting**, select your city and then press **OK key** to save the selected city as your home time zone. (Note changing time zones changes the current time setting)
3. Press **End key** or **Back key** to quit.

## 5 Messages (Menu, 2)



In idle state, press **Menu**, select **Messages** and then press the **OK key** to access the **Messages** interface.

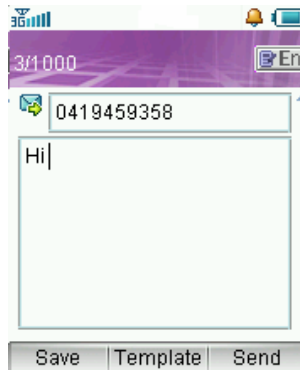

### Create a New SMS Message

1. Select **New message** and then **Text message**.
2. Enter the recipient's number or press **Contacts** and choose the recipient.
3. Press the **Down key twice** to move the cursor to the text field. Enter text using the keypad, press the **# key** to toggle between different text modes (eg Predictive Text, ABC, abc, 123)
4. Characters and punctuation can be shown by pressing the **\* key**. Choose the desired symbol and press **OK key** to insert.

5. Press **Send** to send the message and save it in **Sent**. If the message fails to send it is stored in the **Outbox**.
6. Press **Save** to save the message to **Drafts**.

## Create a New Multimedia Message

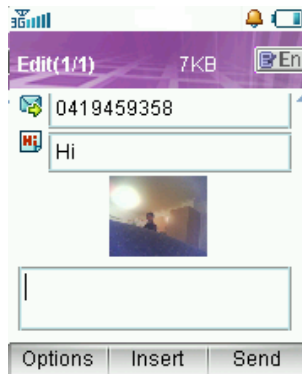

1. Select **New message** then select **Multimedia message**.
2. Enter recipient number or press **Contacts** and choose the recipient.
3. Press **Down key** to move cursor to the title field.
4. Press **Down key** to move cursor to the text field.
5. Press **Insert** to attach an Image, Audio or Video file from your data folder.
6. Press **Options** for additional menu:
  - **Delete image/ Delete audio file/Delete video file:** Delete current file.
  - **Add page:** Add a new page.
  - **Delete page:** Delete current page.
  - **Preview:** Preview the attached file, Press **Left/Right key** to page down.
  - **Previous page /Next page:** View the previous page or next page.
  - **Templates:** Open the templates list etc.

- **Save** : Save the message to **Drafts**.

7. Press **Send** to send the message. If the message fails to send it is stored in the **Outbox**.

## Inbox

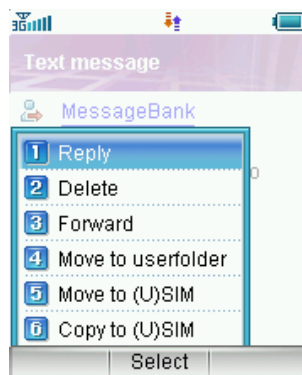

Enter the message list. Use the **Up/Down key** to scroll through the list and press **OK key** to view the details.

From the **Inbox** press **Options** for more menu items as in the picture below.

The menu items are self explanatory and are used to perform the operations to the selected message. Press the **Back Key** to navigate to the previous screen.

## Multimedia Messages (MMS)

The MMS messages presents a similar menu structure with additional options for pictures such as **Set as wallpaper**.

## Outbox

Outbox contains all the messages that failed to send. Press **Edit** to edit and send the message.



## Drafts

If you select **Save** the message will be saved in the **Drafts** folder.

## Sent

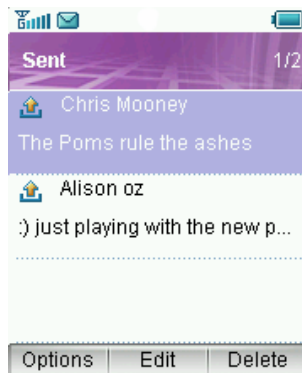

The Sent folder contains all successfully sent messages. Press **Edit** to edit and send the message.

## User folders

You can move received messages from the Inbox to a specific user folder. Press **View** to view messages in this folder.

Press **Rename** to rename the folder.

## (U)SIM box

Select **(U)SIM box** to check the text messages saved in the USIM card. The **Options** are identical to previous menus.

## Multimedia Message Settings

- **Retrieval Settings:** You have three choices:
  - Manual** - retrieve the MMS manually.
  - Automatic** - retrieve the MMS automatically.
  - Manual in roaming** - when you are roaming on a different network you can decide whether to accept the MMS.
- **Delivery mode:** You can set immediate delivery or defer it for a specified period of time.
- **Time per page:** Set MMS time per page.
- **Delivery report:** You can request delivery reports for sent messages. You receive a confirmation from the network when the message is delivered to the recipient.
- **Validity:** You can set the validity period of outgoing messages. Messages are saved on the network for this period or until the message is delivered.
- **Anonymous msg.:** You can choose to accept or reject anonymous messages.
- **APN:** Access Point Name. Preset by your network provider.\*
- **Server address:** Set the server address for MMS.\*
- **Proxy server address:** Set the proxy server address. Preset by your network provider.\*
- **Proxy server port:** Set the proxy server port. Preset by your network provider.\*

\* Changing these settings will affect your browsing and client software.

## Text Message Settings

- **SMS center number:** Set the messaging gateway.
- **Voice mail number:** Set the voice mail number.
- **Expired Time:** Select the period over which the message centre will attempt to deliver the message.
- **Status report:** The network informs you when your message has been delivered.

## Templates Settings

Edit the templates for quick pre-defined messages and frequently-used phrases.

## Memory info.

Check the used, available and total amount of memory on the handset.

## E-mail

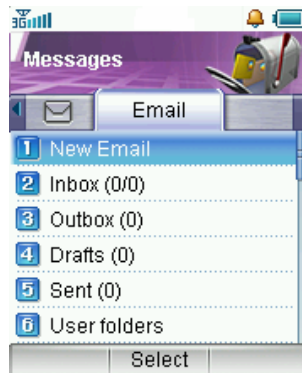

From the idle state press **Menu**, select **Messages** and then the right key to **Email**.

### New E-mail

Select **New Email**. Enter destination address, or select it from your contacts. Use the down button to move between fields. When complete press **Send**.

### Mail Box

The **Mail Box** is self explanatory. **Inbox** contains received E-mails. **Outbox** contains E-mails that failed to send. **Drafts** contains unsent E-mails.

The **Options** submenu is similar to that for text messages, please refer above to that section for any guidance.

### Settings

Your E-mail parameters are preset by your network provider and should not be changed.

### Memory info.

Displays the available and used memory.

## 6 Games & Applications (Menu, 3)



The F151 supports Java downloads for games and applications. You can download new applications from your service provider or other specialist portals. Your handset supports HTTP and WAP+HTTP.

### Applications

1. Start the browser, display the Java MIDlet downloaded to the applications list.
2. Press **Select** to run the file, press **Options** for more choices eg **Delete**.

**Note:** Press **Property** to view file information, author, version, size etc.

### Settings

**Bookmarks:** Store web site addresses for frequently visited sites.

**Proxy settings:** Are preset by your network provider and should not be changed.

## 7 Contacts (Menu, 4)



Press **Menu**, **Contacts** and then press **OK key** to access the **Contacts** menu interface.

The **Contacts** menu allows you to save and manage contacts information. You can add a new address or search saved contacts by name. You can also add a personal ring tone or an avatar image to a contact.

### All Records

1. In **Contacts**, use the **Up/Down** key to select a record and press **OK key** to view the detailed information. Press **Edit** to edit the information, press **OK key** to save.
2. In **Contacts**, press **Send** to send SMS, MMS or E-mail.
3. In **Contacts**, select **Options** to display further menu choices.

# Groups

The default **Contacts** list has groups such as **All, Mates, Family, Friends, Work, VIP, Unclassify** and **(U)SIM**. You can move contacts into specific groups or leave them in the default group.

# Create New Contact

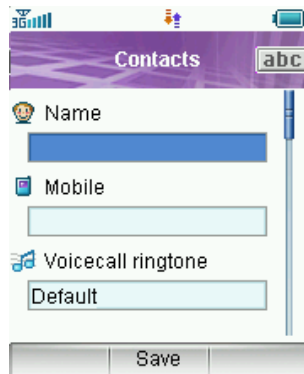

Enter the name and number that you wish to save with your contact information. You can save different ring tones for voice calls, add an avatar, E-mail address and other details.

From the **Contacts** list you can edit an existing contact to update the details as above.

# Set Speed Dial

From your **Contacts** list, highlight the chosen contact. Press Options 3 for Set Speed Dial then choose an available empty number and press OK to Setup. To use your Speed Dial keys long press the relevant key. Eg From the idle screen press and hold key 1 and the phone calls your Voicemail number. Key 1 is preset to access MessageBank whilst in Australia and key 3 is preset to access International MessageBank whilst overseas.

## Copy Contacts from USIM Card to Phone.

Insert your old SIM card. Switch the phone on and then select **Contacts** from the main menu.

Press the **Right** button until you see USIM with the list of **Contacts** from your old SIM card.

Press **Options**, **More**, **Copy all**, and then press **Yes** to confirm.

## Import contacts from Microsoft Outlook

Through the use of the Join Me software it is possible to import contacts from Outlook or similar applications. You can import CSV files or VCF (Vcard) files into the Join Me application and then download them onto your phone. For further information please see our FAQ section on <http://www.zte.com.au/support/faq.htm>.











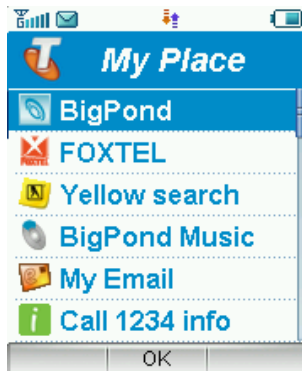

## 8 Telstra Services (Menu, 5)



From the idle screen press **OK** to see the main menu then **OK** again to see the **Telstra Services** menu, **My Place**, as below.

### Telstra Services Menu- My Place



	BigPond	Launches the BigPond web browser
	FOXTEL	Launches FOXTEL services
	Yellow search	Launches Sensis search application for Yellow Pages
	BigPond Music	Connects to the Telstra Music web site
	My Email	Connects to BigPond.com E-mail URL
	Call 1234 info	Connects to Sensis 1234 Information Service
	BigBlogs&Photos	Download wallpapers and other pictures for your phone
	Whereis Maps	Launches Whereis on line search facility for directions and maps
	Downloads	Launches phone download applications for games and accessories
	My Account	View your mobile phone account details

## 9 Calls (Menu, 6)

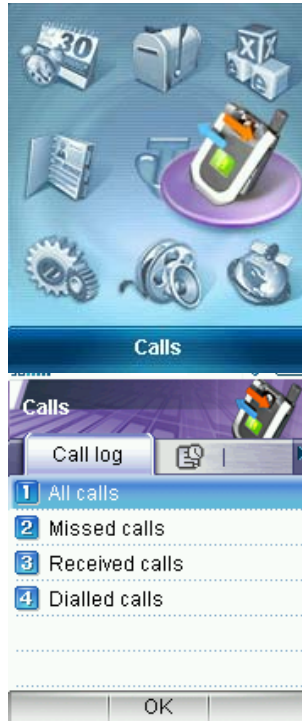

From the idle screen press **Menu**, select **Calls** and then press **OK** to access the **Calls** lists.

### Call log

Stores details of **All calls**, **Missed calls**, **Received calls**, **Dialed calls**.

From the main view you can **Save** the number and add details or from **Options** you can **Send SMS**, **Send MMS**, make a **Voice call**, **Delete** the record, or **Clear** the call logs.

### Calls info.

**Call duration:** You can review the approximate duration of your incoming and outgoing calls. You can check the last call duration and all calls duration. Clear the call duration timers by pressing **Clear**. The default code to reset the timers is 0000.

# 10 Settings (Menu, 7)



From the idle state press **Menu** select **Settings**, then press **OK key** to access the **Settings** interface.

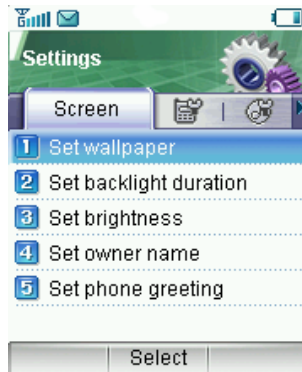

## Screen

In this menu you can configure the **Screen** options:

**Set wallpaper, Set backlight duration, Set brightness, Set owner name, Set phone greeting.**

# Handset



Scroll right to access the **Handset** settings.

1. **Language:** Set the language used in the handset.
2. **Set time:** Use **Arrow keys** to move between time and date.
3. **Network settings:**
  - **Preferred Mode:** You can select **GSM only** , **WCDMA only** or **Automatic**.
  - **Preferred Selection:** On **Automatic** the handset will register with any available

network. On **Manual**, you can specify which network to register with from a list of available networks.

4. **Own phone number:** Add / Edit / Delete your own phone number.
5. **Shortcut keys:** Set the shortcut menu item corresponding to each **Arrow key**.
6. **Modem Settings:** Set the phone modem settings such as username and password.
7. **Access point settings:** This menu shows the access point list.
8. **Restore default settings:** Restore to original factory settings. (Default handset lock code = 0000)
9. **keylock:** Set the time for the auto keylock.
10. **Network time:** Automatically updates the handset time for Daylight Savings etc.

# Profiles

Scroll right for the **Profiles** Menu. The current profile is shown with a red dot.



1. Press **Up/Down key** to select a profile and press **OK key** to activate.
2. Press **Right select key** to **edit** the settings, press **OK key** to modify:
  - **Ringtone**: Select your desired ring tone for incoming calls.
  - **Ring volume**: Adjust the ring volume level.
  - **Ringing type**: vibration mode etc.

- **Message tone**: Set the tone that sounds when a new message arrives.
- **Keytones**: Turn the keypad tones on or off.
- **Warning tone**: Turn the warning tones on or off.
- **Power on/off tone**: Turn the power-up melody on or off.
- **Earpiece volume**: Adjust the volume of the earpiece.

# Security

Scroll right for the **Security** menu.

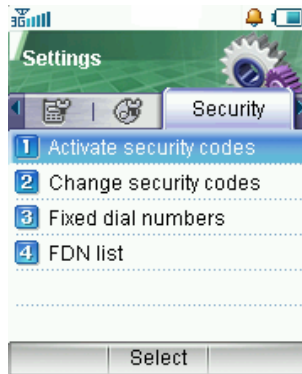

**Activate security codes:** Set the PIN code and Handset lock (default = 0000) .

**Change security codes:** You can change PIN code, PIN2 code and Handset lock code.

**Fixed dial numbers:** If it is **On** you can only dial the numbers in the list. This information is saved on the USIM card. You must enter your PIN2 to unlock this feature.

**FDN list :** Fixed Dial Number – restricts outgoing calls. Press **Add** to add numbers. Use PIN2 to unlock.

**Note:** Personal Identification Numbers (PIN and PIN2) codes protect your USIM card against unauthorized use. The PIN codes are usually supplied with the USIM card. After 3 consecutive incorrect entries your USIM will be blocked (PIN locked). Personal unblocking keys (PUK) will then be required to unlock your phone– talk to your service provider for more details and to get your PUK code.

# Call

## Call Divert

This service enables you to divert incoming calls to other numbers.

After choosing one of the following options, you can enable or disable a divert service to your chosen number:

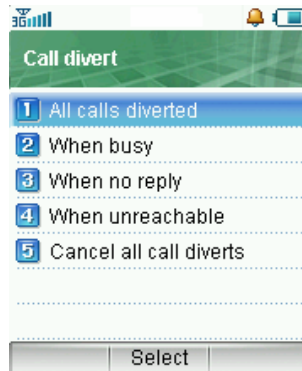

- **All calls diverted:** Divert all incoming calls unconditionally.
- **When busy:** Divert incoming calls when the line is busy.
- **When no reply:** Divert incoming calls when there is no answer.
- **When unreachable:** Divert incoming calls when the phone is unavailable.
- **Cancel all call diverts:** Cancel all forwarding services.

In each menu you can **Activate, Erase** or **Check status**.



## Call Waiting

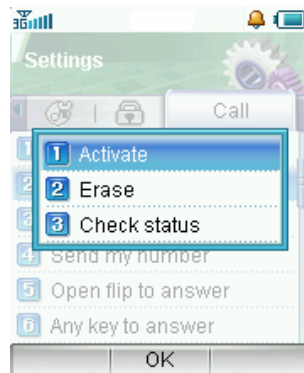

Notifies you of an incoming call while you already have a call in progress. Select **Activate/Erase** to enable/disable this function, **Check status** to query the current status of this function.

## Call Barring

You can restrict making and receiving calls. You will need the barring password from your network provider.

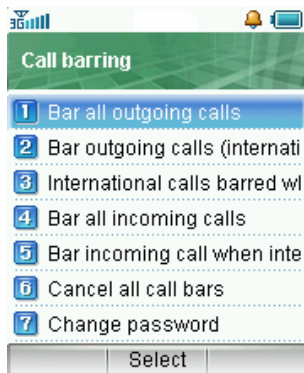

- **Bar all outgoing calls:** Calls can not be made.
- **Bar outgoing calls (international):** International calls can not be made.
- **International calls barred when roaming:** When abroad, calls can only be made to numbers within the current country.
- **Bar all incoming calls:** Calls cannot be received.
- **Bar incoming call when international roaming:** Calls cannot be received when you are overseas.

Select **Activate/Eraser** to enable/disable this function; select **Check status** to query the current status of this function.

- **Cancel all call bars:** Cancel all call barring you have activated.
- **Change password:** Change the barring password. It is needed when you active or erase the call barring.

## Send my number

This function allows you to send or hide your number when making calls.

## Any Key to Answer

If “**On**” you can answer an incoming call by pressing any key except **End key, Back key** and **Left /Right select keys**.

# 11 Multimedia (Menu, 8)



In idle state press **Menu**, select **Multimedia** and then press **OK key** to access the **Multimedia** interface.

## Media player

Your phone can play multimedia (audio or video) files. The player defaults to the last file accessed. Press **Options**:

- **Open**: Open files from **Files, URL, Slide** or **Play list**.
- **Send**: Send the file as a message or E-mail.
- **Mute (#) / Mute off -#**: Mute/Unmute the video files when they are playing.
- **Set as ringtone / wallpaper**: Set the file as ring tone or wallpaper.
- **File info.**: View the file size and time information.

- **Network settings:** Set corresponding network parameters.
- **Help:** Get help about how to use media player.

## Favorites

### Play list

This function enables you to create a list of your favorite audio files. Press **Add** to create a new play list. Use **Mark** to mark the audio file and **OK** to save the marked files. In play list,

1. Press **Play** to play the files. Adjust volume using the **Up/Down key**.
2. Press **Edit** to display the list. Then press **Add** to add new files; Press **Options**→ **Remove** to delete the file; Press **Options**→ **Change Order** to move the file. Press **Save** to save the changes.
3. Press **Options** for submenu:
  - **New Play list:** Create new play list.
  - **Rename:** Change the list name.
  - **Delete:** Delete this play list.
  - **Delete all:** Delete all play lists.
  - **Info. :** View the music file amount and time information.

## Slide Show

Add your pictures by pressing **Add**, browsing to **My Pictures** and **Marking** the pictures you want. Press **Options** for:

- **New slide:** Create new slide.
- **Rename:** Change the slide name.
- **Delete:** Delete this slide.
- **Delete all:** Delete all slides.
- **Info. :** View the image info details.

## Streaming URL

Streaming URL are links to audio or video content available through the browser. The content is only available while you are connected to the server and depends on your network provider. Press **New** to add a new streaming URL. Enter the title and URL address and then **Save** the URL.

When you have **saved** the URL details you can **edit** or choose **Options** for the submenu:

- **New Bookmark:** Create a new bookmark.
- **Send:** Send the URL address as a message or E-mail.
- **Delete:** Delete the address etc.
- **Delete all:** Delete all the URL addresses.
- **Info.:** View title and URL address.

## 12 Browser (Menu, 9)



Your handset has a built-in web browser and 3G opens up a world of communication, information and entertainment services. You can ask for directions within major cities, get the latest news, sports, weather and much more.

Press **Menu**, select **Browser** and then press **OK key** to access the browser interface.

### Home

Takes you to the BigPond web site.

### Go to

This function allows you to store and edit frequently accessed sites. Select **Enter address** to input a new URL, or select the **Last address**, or **Recent addresses** then press **OK**.

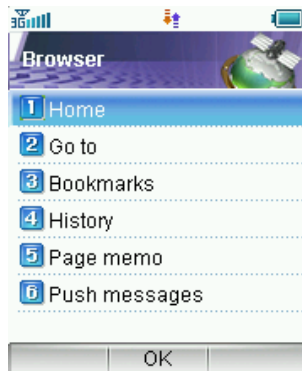

## Bookmarks

All accessed page addresses can be saved as bookmarks in your phone.

Under **Options** you can:

- **Add:** Add a new site to the bookmark list.
- **View:** Load the current page again.
- **Address:** Show current address.
- **Edit:** Edit and save the title and address of the selected bookmark.
- **Delete:** Delete the selected bookmarks.
- **Delete all:** Delete all bookmarks.

## History

This function allows you to check the web sites you have already visited.

## Page memo

This function displays the list of pages saved as an off-line file.

## Push messages

This shows a list of all the messages pushed to your browser. Not all network providers use this feature.

## Options

You can set the Browser settings in this options menu.

- **Home:** Input the homepage of the browser.
- **View:** Change the settings relating to animations, images, tables and scripting.
- **Proxy:** Select to use the proxy or not and set the proxy server address, port, username and password.
- **Cache:** Set the browser cache parameters.
- **Cookies:** Set cookies parameters – cookies can be helpful to remember your own web preferences.
- **Certificates:** View the certificates provided in the browser.
- **Push settings:** Set to receive push messages.
- **APN settings:** Access Point Name. Preset by your Network Provider.
- **Background music:** Set the background music when browsing.
- **Reset:** Restore the original Browser settings.
- **About browser:** View browser information such as version, etc.



# 13 Text Input

Use the **# key** to switch between different text modes ABC, abc, 123 or Predictive Text (En).

## ABC and abc mode

1. Press the key labelled with the required letter, (2 = a,b,c)
  - Once for the first letter
  - Twice for the second letter, etc.
  - Press and hold the key to enter the corresponding number.
2. To insert a space, press **0 key**. To delete letters press the **Clear key**.
3. If the next letter is on the same key, wait until the cursor appears or press **Right key** to the move cursor on.
4. Press the **1 key** repeatedly for common punctuation marks. Press **\* key** to open special characters.

## 123 mode

The 123 mode enables you to enter numbers in a text message. Press the **# key** to switch into number mode.

## Predictive Text (En)

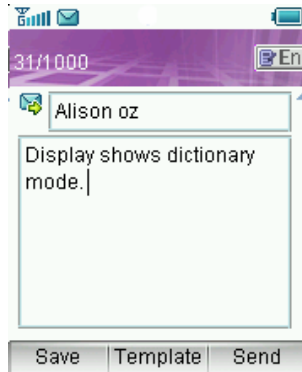

Predictive text is based on a built-in dictionary and generates words from the combination of letters pressed.

1. Press the letter keys once for each letter. For example to write “set”, press **7, 3, 8**.
2. When you finish writing the word and it is correct, press **OK key** to confirm or 0 (space).
3. If the word is not correct use the **\* key** to toggle between different available words.
4. If your word is not available in the dictionary then enter it manually by using conventional abc text mode as above.

## Special Characters



Special characters are selected by pressing the **\* key** during any text mode. Move the cursor to the required symbol and select **OK**.

## Character Chart

Key	Corresponding Characters
1	1 and some common punctuation characters eg . , ? ! @ '
2	ABCabc2
3	DEFdef3
4	GHIghi4
5	JKLjkl5
6	MNOmno6
7	PQRSpqrs7
8	TUVtuv8
9	WXYZwxyz9
0	Space 0
* key	Press * key for character set. Press twice for International Prefix "+"
# key	Toggle different text modes.
Up/Down key	Move the cursor up/down. Move along Tabs
Left/Right key	Move the cursor left/right. Toggle various options
End key	Exit

# 14 Troubleshooting

Please check the manual thoroughly before contacting your service provider.

<b>Symptom</b>	<b>Resolution</b>
“Enter PIN code” is shown	Input the correct PIN number. See <b>Settings-Security</b> .
” No USIM detected” is shown	Check you have inserted a valid USIM card. See <b>Installing the USIM Card</b> .
”Enter the unlock code” is shown	Enter the unlock code. Default is 0000. See <b>Settings, Security</b> .
(No) key tone when pressing keys	Check the <b>Keytones</b> settings in the current <b>profile</b> .
No incoming ring tone	Check the <b>ring tone</b> and <b>ringing volume</b> settings in the <b>profile</b> .
No alarm tone	Check the <b>profile</b> setting (silent) and the alarm ring setting.
A phone number cannot be dialed	Check whether any call restrictions are set. See <b>Call Barring</b> .
Short message cannot be sent	Check the SMS centre setting in the <b>SMS-Settings</b> menu. Restore defaults.
The battery discharges quickly	The battery life is expired. Purchase a new battery from your dealer.
The handset gets very warm.	It is normal for phone to get warm during long calls, when using the browser and when charging the battery.

# 15 Glossary

- **Avatar** – is a small bit-map cartoon style picture.
- **2G** - Second Generation wireless communication system.
- **3G** - Third Generation wireless communication system. 3G is the next generation wireless communication system that offers real-time video streaming services and high-rate packet-data service. 3G is also known as UMTS (Universal Mobile Telecommunications System).
- **Access point** - Access point gives users access to enhanced services.
- **MMS (Multimedia Message Service)** - A message service for the handset environment, that allows videos, pictures, audio files and text to be sent between phones and to E-mail addresses.
- **Roaming** - Use of your phone when you are outside your home area, when traveling for example.
- **USIM** - Universal Subscriber Identity Module. Your USIM is provided by network operator. It carries the authentication and service data for the network operator as well as user-specific data such as Contacts and SMS.
- **Voice mail** - An answering service that automatically answers your calls when you are not available. Others can leave voice messages for you with this service.

# 16 Installing the Join Me PC Software

**Install the CD Software before plugging your phone into your PC.** If your phone has already been plugged in, the correct drivers will not install automatically. See below to re-install the drivers through the Windows Device Manager.

Please follow the installation guide carefully by reading the Quick Start Guide provided and the Read Me file on the CD. The process is to run the Setup File in the Join Me folder on the CD, **then** plug in your handset. Windows will install three sets of drivers. Once this is done, you can run the Join Me software. If the installation fails then you will need to access Device Manager to re-install the drivers. Please see our FAQ section on [www.zte.com.au](http://www.zte.com.au) for full instructions.

To access Device Manager, right click My Computer, select Properties, the Hardware tab, then Device Manager or go through the Control Panel, System. Failed Driver installation is shown by yellow '!' or '?' marks. Right-click to re-install the driver and follow the Found New Hardware Wizard choosing the default options. If the driver still fails to install, go back and select "Install from a list or specific location" then select "Don't Search I will choose". Select the driver from the list and complete the installation. See [www.zte.com.au](http://www.zte.com.au) for screen shots and complete instructions.

# 17 Technical Parameters

<b>Handset</b>	F151 Universal Mobile Telecommunications System, with Tri Band GSM
<b>Dimensions (W×L×H)</b>	Approx 48mm × 109mm × 16mm
<b>Weight</b>	Approx 90g (Including standard battery)
<b>Frequency Standards</b>	WCDMA 850 MHz, GSM 900MHz, GSM 1800MHz, GSM 1900MHz.
<b>Features</b>	MP4 video, MP3 audio, 146MHz Processor, MIDP 2.0 JAVA, 262K Colour Screen, MMS Video, MMS Picture, E-mail, Calendar, Speakerphone, USB PC Connectivity., Compatible with ZTE CK150 Carkit (sold separately).
<b>Battery</b>	800 mA hours, Lithium ion (Li-ion)
<b>Continuous idle time*</b>	200 hours in GSM mode, 300 hours in WCDMA mode.
<b>Continuous talk time*</b>	200 minutes on GSM network, 95 minutes on WCDMA network.
<b>Charge time</b>	Approx 3 hours
<b>Battery Life</b>	Approx 10,000 charge cycles.

\*The phone's talk time and idle time are based on ideal working environments. The use of extended backlighting, browser, and network conditions can reduce battery life and talk/idle time.

## 18 Environmental Statement

Your F151 UMTS handset is made using the latest manufacturing techniques and environmental standards to reduce waste and hazards to the environment. However at the end of life of the equipment the manufacturer recommends that you return the handset and accessories to your nearest re-cycling depot or send it to our recycling agent below. Valuable materials such as gold, silver, and copper can be recovered from the handset. Any toxic materials will be prevented from entering the environment and the waste materials will be recycled.

**At the end of life of the equipment you can send your handset, battery and charger to:**

MRI (Australia) Pty Ltd

20-24 Dennis St

Campbellfield

VIC 3061

[www.mri.com.au](http://www.mri.com.au)

MRI Australia recycles every part of the equipment and diverts over 90% of the materials from landfill for re-use.