

TELSTRA T816 USER GUIDE

WHAT'S INSIDE

A QUICK LOOK AROUND YOUR DEVICE	1	PLAY VIDEOS	51
GETTING STARTED.....	3	GALLERY.....	51
PHONE CALLS	20	SOUND RECORDER.....	51
CONTACTS	25	SECURITY	54
MESSAGES.....	26	UPDATING YOUR DEVICE	56
CONNECT TO A COMPUTER	40	TECHNICAL SPECIFICATIONS:	56
USING THE BROWSER	44	TROUBLESHOOTING	59
BLUETOOTH.....	44	WARRANTY INFORMATION.....	64
USING MULTIMEDIA FUNCTIONS.....	47	SAFETY	65

ZTE Australia is on Facebook , Google+, Twitter and Instagram.

© ZTE 2015 V2.0



A QUICK LOOK AROUND YOUR DEVICE



GETTING STARTED

INSERT YOUR SIM CARD

1. Open the back cover using the thumb notch in the bottom left corner:

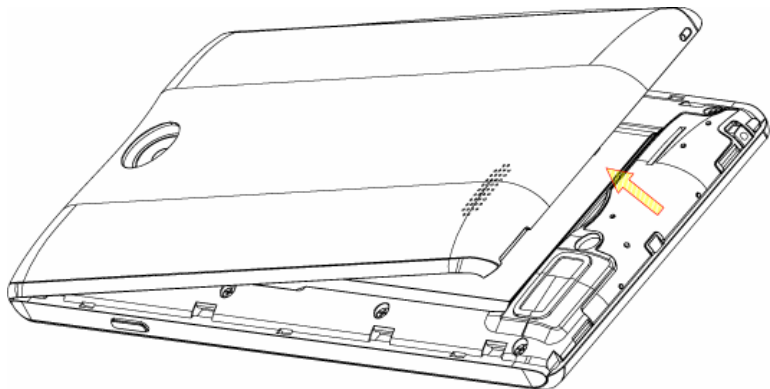

2. Insert your SIM card carefully into the SIM slot as shown:
This handset accepts the Standard sized (2FF) SIM card. Do not use micro-SIM or SIM card adaptors which can damage your device.

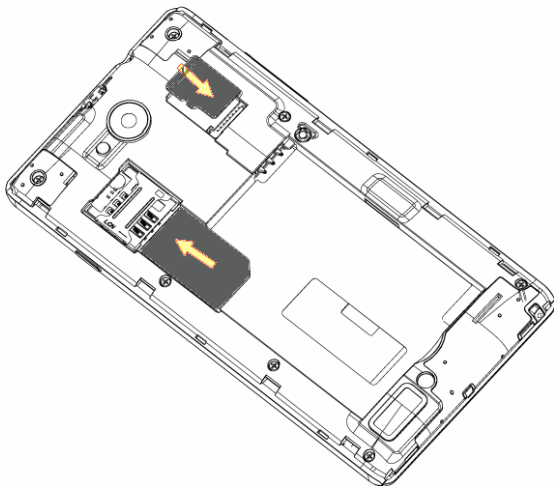

3. Expand the device memory with a microSD(HC) up to 32GB (optional):

4. The battery will only fit one way, just check the gold pads on the battery line up with the gold springs in the phone.

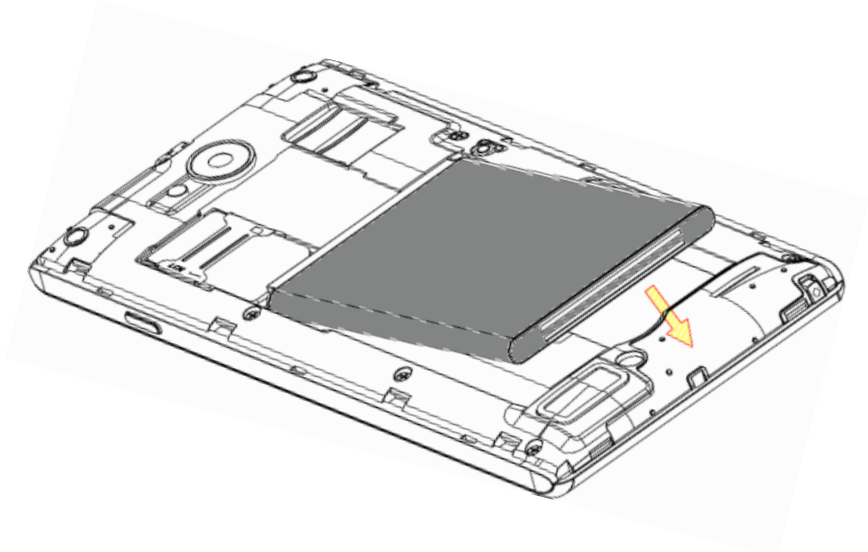

5. Replace the battery cover and press to click into place.

SWITCH YOUR DEVICE ON OR OFF, CHARGE YOUR BATTERY

- Press and hold the Power Key to turn on your phone.
- To turn it off, press and hold the Power Key to open the options menu.

CHARGE THE BATTERY

- Check the correct orientation of the lead, then insert the charger lead carefully.
- Do not force the connector into the charger jack.
- Connect the charger to a standard AC wall outlet.
- Disconnect the charger when the battery is fully charged.
- If the phone is on, you'll see the charging icon  on the status bar.
- If the battery is low, there will be a pop-up message on the screen. As you charge your phone, the lock screen will tell you the battery level each time you wake up your phone.
- On first use please charge the battery for 3-4 hours. It is better to keep your battery topped up than to let it fully discharge.

Important Notes:

- Only use the AC charger and USB lead supplied.
- Insert the charger lead carefully.
- Check the plug and socket are aligned correctly.
- Do NOT use excessive force which may damage the USB port.
- Be careful to avoid tripping on the lead whilst it is plugged in.
- Physical damage to the USB port is NOT covered by warranty.
- Normal charge time is 3-4 hours.
- Do not leave on charge for more than 24hrs.
- To maximise battery life limit multimedia functions.
- Charge the battery between 0°C~45°C. Charge the battery promptly when flat.
- With poor network conditions (less than 2 bars) battery life is reduced.
- When not using the phone for long periods remove the battery.

TIPS TO MAXIMISE BATTERY LIFE

- After 2-3 charge / discharge cycles the battery life will improve.
- Use regular top up charging rather than letting the battery fully discharge.
- Always charge promptly when flat.
- To avoid the battery entering a deep discharged state charge the battery promptly when flat.
- If the battery is deeply discharged it can take 30 minutes to start charging. Leave it on charge to recover the battery.
- Keep your handset and battery cool. High temperatures degrade the battery more quickly.
- Normal charge time is 3-4 hours. Do not charge more than 24hrs.
- When not using the phone for long periods charge to approx 40% and remove the battery.
- With low network signal conditions battery life is reduced.
- Turn off Bluetooth and Wi-Fi when not in use, and set the screen brightness to automatic to maximise battery life.

GOOGLE ACTIVATION WIZARD: CREATE OR LOG IN TO A GOOGLE ACCOUNT
We recommend you log in or create a Google account to enable on line services.

Follow the on screen wizard to create or log in to an existing Google account.

TIPS

If you set a lock code on your device and then forget the pattern or PIN number it can be reset using your Google Account.

If you have not set a Google account then you need to do a factory reset. From the lock screen condition, press the Emergency Call button, then enter *983*987# into the dialler. Follow the prompts to reset your phone.

WAKE UP FROM SLEEP MODE

- Press the Power key to activate the display.
- Long press on the screen to unlock.
- You can pinch out on the lock icon to get quick access to Phone, Email, Messages, Audio, Camera and Calendar apps.

SWITCH YOUR HANDSET TO SLEEP MODE





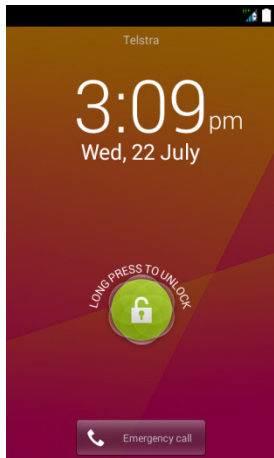

Press the Power key to activate sleep mode.

Sleep Mode activates automatically with the timeout set from Options > System settings > Display > Sleep.



TIP

If you set an unlock pattern, PIN or password you need to enter it to unlock the screen. If you forget your pattern or PIN use your Google Account password to reset the phone. This will only work if you register a Google account with this handset.

Keys	Function
Power Key	Hold down to power on your phone. Press to switch to sleep mode. Press to wake up. Hold down for Silent mode, Vibrate, Flight mode, Power.
Back 	Press to go to the previous screen. Press to exit applications.
Home 	Press to return to the Home Screen from any screen. Hold down to access Google Search
Options 	Press to get the options on the current screen. Hold down to see the recently used applications.
Volume Keys	Use to control the volume Up and Down
	Phone icon – Open the dialler for Calls
	Contacts – Open your Phonebook for all your Contacts
	Apps – Open the Applications menu
	Messages – go to the Messages app, for SMS and MMS

THE HOME SCREEN

Slide the Home Screen left or right to view additional pages.

Long press on the screen to change your wallpaper.

Tap the Google Search bar to search the web, or touch the mic icon to speak your search.

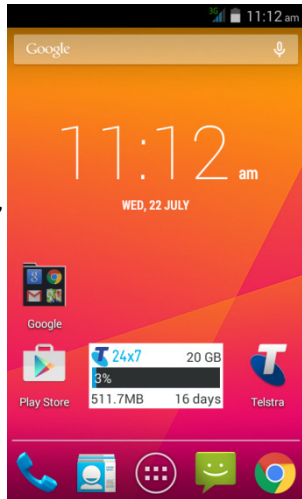

OPTIONS

Press the Options Key for

Wallpaper, set background image for the Homescreen or Lock screen

Manage Apps, view Downloaded, Running and All apps

System settings, shortcut to device Settings

ADD OR REMOVE ICONS & WIDGETS

Press  to go to Apps then long press any icon to add it to the desktop.

- Hold the icon to move it and release to place it on the home screen.
- Drag and drop the item in the trash to delete it.
- Eg, Add the Analogue Clock Widget:

Press  > Select the Widgets tab at the top of the screen

Press and hold on the Analogue Clock

Drag the Clock to the required location on your Homescreen

Release to place the clock in the desired location.

TIP

Touching the Analogue Clock presents the Alarm menu

THE NOTIFICATIONS PANEL

The Notifications Panel at the top of the Home Screen shows useful device and status information. Pull your finger down from the top of the display to open the Notifications Panel.

PHONE STATUS AND NOTIFICATION ICONS



Signal strength



Flight mode



Blue – Connected



Data transfer



No signal



Emergency Calls only



Battery is very low



Battery is full



Battery is low



Battery is charging



Speaker mode is on



Speaker is muted



Vibrate mode enabled



Microphone is muted



Bluetooth is on



FM Radio



GPS is on



USB connected



Alarm is set



Connected to a Wi-Fi network

NOTIFICATION ICONS



New Email



New instant message



New SMS/MMS



Upcoming event



New voicemail



Song is playing



Missed call



Downloading data



Call in progress



Content downloaded



Call on hold



Uploading data



Call forwarding on



More notifications



Problem with SMS/MMS



Headset connected

ACCESS THE QUICK SETTINGS PANEL



Swipe down from the top of the home screen and touch the Quick Setting icon. Tap to enable or disable the features. Some icons can be configured with a long press (press and hold).

APPLICATIONS AND SETTINGS

Tap  to access Applications. Flick the screen left or right to scroll through all the Apps. Touch the Widgets tab to see available widgets. You can install additional applications by going to Play Store

INSTALL APPLICATIONS FROM GOOGLE PLAY STORE



Tap Play Store from the Home Screen to download and install applications from the Google. Select the item and tap Install.

- You need a Google account to access Play Store
- Follow the wizard to sign in to an existing account or to create a new account.

UNINSTALL APPLICATIONS

- From the Home screen tap Options > Manage apps
- Select the application to remove
- Tap Uninstall, tap OK to confirm.

MULTI-TASKING

Run multiple applications simultaneously. Press the Home key from any application to launch, open or view something else. The original application will be suspended until you return to it.

TIPS

If you are finished with an application use the Back key to exit the application. If you leave applications running in the background the system memory will be depleted and the device will be slow to respond. Return to the app and close it, or from the Home screen press Options > Manage Apps > Running and select tasks to close them down.

OPEN RECENTLY USED APPLICATIONS

Press and hold the Options Key  from any screen to view recently used applications.

Tap Options > System Settings from the Home Screen:



SETTINGS MENU	
Wi-Fi	Connect to Wi-Fi devices and Networks
Bluetooth	Connect to Bluetooth devices and Networks
Data usage	View your data usage, and control Mobile Data
More...	Flight mode, Default SMS app, Tethering and portable hotspot, VPN, Mobile networks, USB internet
Sound	Sound levels, ringtones, notifications, vibrate.
Display	Brightness, screen timeout, auto rotate screen etc.
Storage	Check memory status. Mount or unmount the SD card.
Battery	See what has been consuming your battery power.
Apps	Manage applications, set Quick Launch shortcuts, see running services and battery usage.
Location	Configure Location modes and services

SETTINGS MENU

Security	Set screen locks, enable SIM PIN etc
Language & input	Set the language and keyboard options.
Backup & reset	Backup your data on Google servers, and perform a factory reset to remove your default account.
Accounts	Add and remove accounts.
Date & time	Set the date, time, time zone, and formats. Enable automatic time update.
Scheduled power on&off	Set automatic power on and off times.
Accessibility	Download a screen reader application and make other Accessibility settings
Printing	Interfaces your handset to Google Cloud Print
About Phone	Storage card updates, Status, software version, etc

PHONE CALLS

MAKE A CALL FROM THE DIALER

- Unlock the phone and press the Call Key 
- Touch  for the Dial pad or select from Favourites or Contacts
- Tap numbers on the dial pad using the tabs at the top of the screen.
- Tap the call key  to make the call.
- Press End to end the call.

FUNCTIONS DURING A CALL:

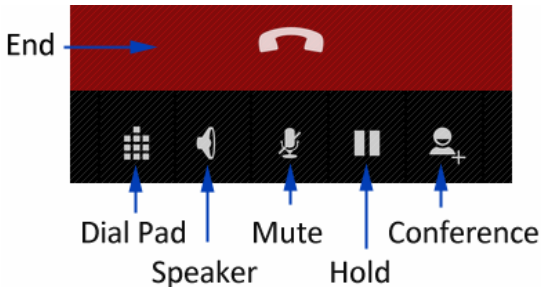

During a call when you move the handset away from your ear the screen lights up. Use the buttons for the features described:

Dial Pad – enter DTMF tones

Speaker – Use Handsfree, Speaker mode

Mute – Mute the microphone

Hold – Place the caller on Hold

Conference – Dial in another party, the first call is put on hold.

MAKE A CALL FROM CONTACTS

- Tap  from the Home Screen. Contacts are displayed in alphabetical order.
- Slide up or down to scroll through your Contacts list.
- Tap to select the Contact then tap to call.



TIP

Tap  to search for a Contact.

MAKE A CALL FROM CALL LOGS

- Unlock the phone and press the Call Key 
- Recent calls and favourites are shown on the screen
- Tap the Clock icon to view your Call History
- Scroll and tap the required number to start the call, tap the arrow button to view the call details if required

MAKE A CALL FROM A TEXT MESSAGE

- Unlock the phone and press  for messages. Tap the thread that contains the phone number to call.
- Tap the number then tap  to call
- Press End to end the call.

TURN THE SPEAKER ON/OFF (HANDSFREE)

Tap the Speaker icon during a call to use handsfree mode.

MUTE A CALL



Tap Mute icon during a call to mute your microphone.

MAKE A CONFERENCE CALL

A conference call can be made between yourself and two or more other parties.

- Call the first number.
- While you are connected, tap the + icon to add another call
- Call the second number.
- While you are connected to the second number, tap **Merge**
- To add the third party, tap + again.
- Dial the number, and when connected, tap **Merge**

MAKING AN INTERNATIONAL CALL

- Press the Call Key  on the home screen to open the dialer.
- Hold down the 0 key to enter the '+' symbol for International Dialling
- Enter the full phone number.
- Tap  to make the call.
- Press End to end the call.

ANSWER AN INCOMING CALL

An incoming call presents three options:

Drag  right to answer the call



Drag  left to reject the call.

Drag  to Messages to send an SMS.

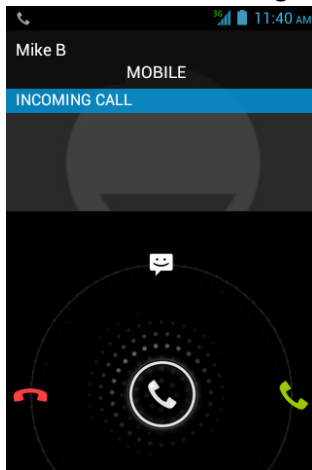
The default return SMS can be set at Dialler > Settings > Other settings > Quick responses.



INSERT A PAUSE OR WAIT SYMBOL INTO A PHONE NUMBER

- Enter the phone number on the Dial pad.
- Press Options  > Add 2-sec pause to add a Pause
- Press Options  > Add Wait to wait for the next key press.



CALL SETTINGS



From within the Dialler, press Options > Settings:

- Voicemail
- IP prefix number
- Voice Call
 - Call forwarding
 - Call barring
 - Additional settings
- Fixed Dialling Numbers
- Minute reminder
- Other Settings
 - Quick responses
 - TTY mode
 - International dialing assist

CONTACTS (PEOPLE)



Add contacts to your phone and synchronise them with your Google account or other accounts that support contact syncing.

To see your contacts, touch **Home** > . From there, touch the tabs on the top of the screen to quickly switch to contact groups  or favourites .

- Touch Home >  and touch the all contacts tab  to access your contact list.
- Scroll through the list to view all your contacts.
- Touch a contact to view its details.

TIP: There is a slider on the right side of the screen. Use this to quickly scroll up and down your Contacts.

Adding a New Contact



- Touch Home >  and touch the all contacts tab .
- Touch  to add a new contact.
- Touch the account field on the top of the screen to choose where to save the contact. If a sync account is selected, the contacts will be

synced automatically with your account online.

- Enter the contact name, phone numbers, email addresses, and other information.
- Touch DONE to save the contact.

Setting Up Your Own Profile

You can create your own name card in your phone.

- Touch Home >  and touch the all contacts tab .
- Scroll to the top of the screen and touch Set up my profile.
- Edit your profile information and touch DONE.

Import, Export, and Share Contacts

You can import/export contacts from/to your SIM or Storage (microSD card). This is useful when transferring contacts between different devices.

Import your SIM card Contacts to add more features such as dedicated Ringtone, Photos etc.

Import Contacts From the SIM Card

- Touch Home >  > Options > Import/export
- Select Import from 'Telstra Mobile' (SIM card)
- Tap Next to continue
- Select the destination to copy your contact to, this can be your Google account or saved on the phone only. Tap Next to continue.
- Tap to select individual contacts, or use the box in the top right to Select All. Tap OK when done.



Import Contacts From the microSD Card

- Touch Home >  > Options >
- Touch Import/export > Import from S
- Select an account to save the contacts.
- Select the vCard file(s) in the microSD card and touch OK.

Export Contacts to the SIM Card



- Touch Home >  > Options > Import/export
- Select to Copy Contacts From, press Next to continue
- Select Copy Contact To 'Telstra Mobile', press Next,
- Tap individual contacts, or the box to Select All and then touch OK.

Share Contacts



- Touch Home >  and touch the all contacts tab .
- Locate and touch the Contact
- Touch Options > Share
- Choose to share via Bluetooth, Email, Gmail, Messaging, etc
- To share Multiple contacts touch Options > Share visible contacts, select the Contacts > OK, then select the Share path.

Add a Contact to Favourites



You can add the contacts used frequently to Favourites, so you can find them quickly.

- Touch Home >  and touch the all contacts tab .
- Touch a contact and then touch  to add to favourites.
- Contacts must be saved in Phone Storage, or your Google account to add to Favorites.





Remove a Contact From Favourites

- Touch Home >  > touch the favourites tab .
- Touch a favourite contact and then touch .



Using Groups

- Touch Home >  and touch the contact groups tab .
- Touch  to create a new group.
- Touch the account field on the top of the screen to choose an account for the group.
- Enter the group name and touch DONE.



Add Members to a Group

- Touch Home >  and touch the contact groups tab .
- Touch a group and then touch .
- Touch to select the contacts to add as group members.
- Touch .



Delete a Group

- Touch Home >  > touch the contact groups tab .
- Touch a group and then touch Options > Delete group.
- Touch OK to delete the group. The contacts in the group will not be deleted.

Edit a Group

- Touch Home >  > touch the contact groups tab .
- Touch a group and then touch Options.
- Touch Edit group to edit the group name. Or touch Select item(s) to select the members you don't need and remove them.

Searching for a Contact

- Touch Home > .
- Touch  on the bottom of the screen.
- Input the contact name to search. The contacts matched will be listed.

Edit Contact Details

- Touch Home > .
- Touch a contact to edit and then touch Options > Edit.
- Edit the contact and touch DONE when finished

Set a Ringtone for a Contact (Contact must be saved on the phone)

- Touch Home >  Touch a contact to set a ringtone and then touch Options > Set ringtone (Contact must be saved on the phone)
- Select a ringtone and touch OK.

Delete a Contact

- Touch Home > .
- Touch a contact to delete and touch Options > Delete.
- Touch OK to confirm.

To delete several contacts:

- Touch Home > .
- Touch Options > Delete contact
- Touch to select the Contacts, then touch OK to confirm.

MESSAGES





SMS AND MMS MESSAGES



From the Home screen tap the messages icon  to access SMS and MMS messages.

Unread message(s) display the messaging icon in the Notifications bar. Open new messages from the Notifications bar or the Messaging Screen. Tap the message to read it.

COMPOSING AN SMS

- If the Messages app opens into an existing thread press the Back key to return to the SMS main menu.
- Tap the messages icon >  to Compose a new message.
- Enter the recipient's name or number. As you enter letters, matching Contacts are shown. Touch a Contact to select a recipient from the list or tap the Contacts icon  to see all Contacts.
- Tap 'Type text message' to enter your message.
- Tap  to Send when done.

COMPOSING AN MMS

- Tap the messages icon >  to Compose a new message.
- Enter the first letters of a contact to display matching names or tap 123 to enter numbers manually.
- Tap  to see your Contacts list.
- Tap + to add an attachment.
- Choose your attachment type
- Tap Send when done.

TIPS

Adding or removing the **Subject** or **Attachments** will convert the message from SMS to MMS and vice-versa. An MMS allows for more text space without being charged for multiple SMS messages. Tap Options > **Add subject** to enter the subject if required.

FORWARDING A MESSAGE

Long press the individual message to get further options such as Forward, Delete, View message details etc.

MANAGING MESSAGES AND MESSAGES THREADS

SMS and MMS messages sent and received are grouped into message threads in the Messaging screen. Message threads show you the history of messages from the specific contact. Threads are sorted by received time, with the latest one at the bottom.

REPLY TO A MESSAGE

- Tap the message (or thread) you want to reply to from the Messaging Screen.
- Tap Type to compose and enter the contents of your message.
- Tap Send when done.

ACCESS DRAFT MESSAGES

Draft messages are automatically saved when you exit the message application without having sent the message. If you have any messages in Draft status they are marked in red with **Draft**

DELETE A MESSAGE (THREAD)

- Tap the Messages icon  then press and hold a message to delete.
- Tap Delete to confirm.
- To delete an individual message (not a thread) tap and hold the message and select Delete from the available options.

MESSAGE SETTINGS

Tap Messages > Options > Settings to configure message settings such as Font size, Storage settings, SMS Settings, MMS Settings, Notifications settings and Signature settings.

MULTIPLE SMS MESSAGE CHARGING:

A standard SMS message can contain up to 160 characters. If you exceed this length the message will be sent as more than 1 SMS. You will be charged for multiple SMS messages depending on the length.

SET YOUR EMAIL ACCOUNT



Create an Email account to receive Emails on your phone.

- Tap Apps > Email to set up your email account
- Enter your Email address and Password
- Follow the prompts. You may need to refer to your email service provider to complete the settings.
- Set your required options choosing from the Account options screen.

You can also use web based email accounts or download specific email clients for your email provider.

COMPOSE AN EMAIL

- Tap Apps > Email > to write a new email
- Tap the To field and enter the recipient's address. Tap Options > Add Cc/Bc to add more recipients if required.
- When you enter the address, the matching addresses saved in your Contacts will be displayed. You can tap the recipient from the list.
- Enter the subject and the content of your Email. Tap to send.

REPLY, REPLY TO ALL, FORWARD AN EMAIL

- Tap Apps > Email to see your Inbox.
- Touch the email
- Select the icons to Delete, Reply, Add to Favorites or view next unread.
- Enter the contents / recipients of your Email. Tap Send.
- Tap Options for Reply All, Forward, Move, and Settings.

EMAIL SETTINGS

Tap Apps > Email > Options > Settings

ACCOUNT SETTINGS

- Account name: Set your account name.
- Your name: Set the name displayed on the outgoing message.
- Signature: Edit your signature.
- Quick responses, you can add some default text to append to your emails
- Default account: Send email from this account by default.
- Inbox check frequency: Set the email checking frequency.
- Sync email

- Download attachments
- Email notifications: Status bar notification for new Email
- Choose ringtone: Incoming Email notification
- Vibrate: Enable vibrate with ringtones when Email arrives.

SERVER SETTINGS

- Incoming settings: Set the incoming server settings.
- Outgoing settings: Set the outgoing server settings.
- REMOVE ACCOUNT

CONNECT TO A COMPUTER

Transfer audio, video and picture files between your handset and your computer.

PC

Connect your handset using the USB data lead supplied.

First time, select Install driver on the handset notifications window.

On your PC, open CD Drive USB_Driver from Windows Explorer, then double click Setup to install the handset.

Subsequently, select Media Device (MTP) from the notifications window, which will open the handset in Windows Explorer.

MAC

On your MAC, download and install Android File Transfer.

Connect your handset using the USB data lead supplied.

Select Media Device (MTP) from the notifications window, which will open the handset on your MAC.

CONNECT TO THE INTERNET

You can access the internet through the mobile network or via Wi-Fi. When logged on to a Wi-Fi connection, all data will be sent via your Wi-Fi network.

To disable mobile network data slide down from the top of the handset screen to open the quick settings panel, then switch off data connectivity using the Data conn. button.

WI-FI

Wi-Fi provides wireless Internet access over distances of up to 100 meters.

- Tap Home > Options > System settings > Wi-Fi
- Touch the Wi-Fi switch to turn Wi-Fi on.

CONNECT TO A WI-FI NETWORK

- Tap Home > Options > System settings > Wi-Fi
- The available Wi-Fi network names and security settings (open or secured) are displayed.
- Tap a network to connect.
- An open network will automatically connect,
- If you select a secured network you need to enter a password.

CHECK THE WI-FI NETWORK STATUS

- Check the Wi-Fi icon  in the status bar.
- Tap Home > Options > System settings > Wi-Fi, tap the current wireless network to view the network status.
- Tap Options > Advanced > Wi-Fi sleep policy to leave Wi-Fi always on, or set other options.

TIP

A question mark on the Wi-Fi notification lets you know of an open Wi-Fi network. You can switch off these notifications from Wi-Fi > Options > Advanced > Network Notification

SET UP A WI-FI HOTSPOT

A Wi-Fi hotspot shares your network internet connection with other devices nearby. For example, if you are travelling you can connect your laptop wirelessly to your handset to use the internet.

Tap Home > Options > System settings > more > Tethering & portable hotspot > Wi-Fi hotspot

Touch Wi-Fi hotspot > Set up Wi-Fi hotspot to change the SSID and password if required.

USING USB MODEM TETHERING

Use USB tethering to connect a computer to the internet using your device network connection.

Plug your handset to a computer using the USB lead supplied.

Tap Home > Options > System settings > more > Tethering & portable hotspot > USB tethering.

Settings > More > USB Internet allows you to share a PC based internet connection onto your phone. Selecting this will disable your mobile data. On your PC you need to 'share' your internet connection to your phone.

USING THE BROWSER

Use the Google Search bar on the Home Screen or use Google Chrome.



- Tap the Google Search box on the Home Screen.
- Enter your search request using the keypad.
- Press the arrow when done.
- Tap the microphone icon  to use speech recognition. Speak your request clearly into the handset microphone.

The first time you open Chrome you are guided through how to use by on screen instructions and demos. Enter any search directly in the top bar. Press Options for new Tabs, Incognito browsing, Bookmarks and other Settings options.

BLUETOOTH

Bluetooth enabled devices can exchange information within a distance of about 10 meters without any physical connection. The Bluetooth devices must be paired to share information.

TURNING BLUETOOTH ON OR OFF

- Switch Bluetooth on or off from the quick settings panel or
- Tap Options > System settings > Bluetooth
- Tap the switch to turn Bluetooth on.
- The  icon is displayed in the status bar.
- Tap the switch to turn Bluetooth Off when required.

MAKE YOUR DEVICE VISIBLE TO OTHER DEVICES

- Tap Options > System settings> Bluetooth settings.
- Tap the switch to turn Bluetooth on.
- Touch the check box to make your device visible to other devices.

CHANGE YOUR DEVICE NAME

- Tap Options > System settings > Bluetooth
- Select the Bluetooth check box to turn on.
- Tap Options > Rename phone
- Enter the name and tap OK.

PAIR WITH ANOTHER BLUETOOTH DEVICE

- Both devices must have Bluetooth turned on.
- Tap Options > System settings > Bluetooth
- Tap Search for devices to display available devices in your vicinity.
- Tap the device to pair with and enter your PIN if required. The same PIN should be used on both devices.

USING MULTIMEDIA FUNCTIONS

APPS > CAMERA

Line up your shot and tap the shutter button to take the picture.

- Tap the thumbnail in the bottom corner of your screen to view the picture.
- Tap the Settings button to review the camera settings

APPS > CAMERA > VIDEO RECORDER

- Tap the video icon in the camera app.
- Tap the shutter button to stop shooting
- Tap the icon in the right corner to view the last video clip.
- Tap the Settings button to review the video settings

FM RADIO

To use the FM radio you must insert the headphones as the antenna.

OPEN THE FM RADIO

- Insert the headphones
- Tap Home > Apps > FM Radio
- Touch the arrow controls to scan for available channels
- Press the star to add to favourites
- Press Options to view your Channel list where you can long press on the channel to rename or delete it.
- Press the Power symbol to close the radio, otherwise it will continue to run in the background.

MUSIC

You need to have audio files stored on your phone or memory card. Use downloads, Bluetooth or PC Connectivity to save files onto your memory card.

- Tap Home > Apps > Music
- Select from Songs, Playlists, Folders, Albums, Artists or Genre
- To play continuous tracks, select Songs > Options > Play All
- To play an album select Album then click the first track

CREATING PLAYLISTS

- Select a music file to add to a new playlist.
- Tap and hold on the file until a shortcut menu pops up.
- Tap Add to playlist.
- Tap New.
- Enter the playlist name and tap Save.
- The playlist is created and the selected file is added to the playlist.

MANAGING YOUR PLAYLISTS

- Tap Playlist from the Music Screen to view all playlists.
- Hold on the playlist you want to play or edit until a shortcut menu pops up.
- Tap Play to play the playlist.
- Tap Delete to delete the playlist.
- Tap Rename to edit the playlist name.

SETTING A SONG AS RINGTONE

- Open the folder where the song you want to set as ringtone is.
- Hold on the song until a shortcut menu pops up.
- Select Use as ringtone.

TIPs

You can also set a song as a ringtone when you are playing it by tapping Options > Use as ringtone.

The play controls are also available on the Control panel

PLAY VIDEOS

Use Gallery or Videos to view videos.

GALLERY

Use Gallery to view pictures and play back videos. You can also set pictures as wallpaper, contact icons and share them with your friends.

SOUND RECORDER

Sound Recorder enables you to record voice memos that you can also set as a ringtone.

Tap Home > Apps > Sound Recorder.

GOOGLE APPLICATIONS

SIGN IN OR CREATE YOUR GOOGLE ACCOUNT

Sign in to your Google Account to synchronise Gmail, Calendar, and Contacts between your phone and the web.

- Tap a Google application, such as Gmail or Play Store.
- Follow the instructions in the wizard and tap Next.
- Tap Sign in if you have a Google account.
Enter your user name and password, and then tap Sign in.
- Tap Create if you do not have a Google account.



USING GMAIL



Gmail is Google's web-based email service. Gmail is configured when you sign in to your Google account. Depending on your synchronisation settings, Gmail on your phone is automatically synchronised with your Gmail account on the web.

Tap Apps > Gmail to open.

CREATE AND SEND AN EMAIL

- In the Inbox, press Menu and then tap 
- Enter email address in the To field. If you are sending an email to several recipients, separate the email addresses with a comma. You can add as many message recipients as you want.
- Enter the email subject, and then compose your email.
- After composing your email, tap  to Send.

USING GOOGLE CALENDAR

Tap Home > Apps > Calendar to use Google Calendar. You can use the calendar to schedule appointments, meetings and other events. Your appointments are displayed on the screen as they are scheduled. All appointments are synchronised to your Google account, which enables you to share your schedule, get your entire calendar on the go, and receive reminders for upcoming events.

SECURITY

SET A SCREEN UNLOCK PATTERN, PIN, OR PASSWORD

Protect your phone from unauthorised use by creating a personal unlock pattern, Voice Unlock, PIN, or password. Use a pattern, PIN or password you can easily remember. Adding a Voice Command can unlock the phone and launch a particular application such as Messaging, Phone or Camera.

- Tap Home > Options > System settings > Security > Screen lock
- Choose from Long press, Voice Unlock, Pattern, PIN or Password.
- Example for Pattern:
- Watch the demo and tap Next
- Draw a pattern of your choice, tap Continue
- Draw the pattern again and tap Confirm.
- We recommend you register a Google account before setting your unlock pattern, PIN or Password. After five incorrect entries press Forgot Pattern to enter your Google account password to reset the screen lock.

UNLOCK THE SCREEN WITH A PATTERN

- Press Power Key.
- Draw your pattern to unlock the screen. If you make a mistake you can try again up to five times.

If you forget the unlock pattern then after five attempts you can enter your Google account details to unlock your device.

SET A SIM CARD PIN LOCK

- Set a PIN code on your SIM card to prevent others from using your account.
- The initial PIN code is provided by your service operator.
- Tap Options > System settings > Security > Set up SIM card lock.
- Select Lock SIM card. Enter the PIN and tap OK.

CHANGE SIM PIN

Before changing the SIM PIN, you need to enable it.

UPDATING YOUR DEVICE

Your phone can download and install Software updates.

Apps > System updates

The software update service checks an online server to see if any updates are available for your phone. If an update is available you can choose whether to download and install the update.

Downloading via Wi-Fi is highly recommended. Data usage charges will apply if downloading via mobile networks. International roaming data charges will apply for customers downloading the upgrade on a mobile network whilst travelling outside of Australia.

A firmware update will require a restart of your device.

BACK UP AND FACTORY RESET

Easiest Way, Use an SD Card.

Insert a microSD card.

Use the built in Backup App to back up all your Apps and Data.

Manually copy all photos from File Manager > Phone Storage > DCIM to SD > DCIM

Back up photos on line using Google Photo

Open the Photo App, this will save a copy of all your photos to your Google Account

Copy Photos to a computer

Insert the USB lead into a PC. Connect using MTP mode, then transfer all the photos from your device onto your PC.

FACTORY RESET

Go to Settings > Backup & reset > Factory data reset.

TECHNICAL SPECIFICATIONS:

Size and Weight	126.5 × 64 × 9.8 mm. 125g with battery
Networks	3G UMTS 850, 2100 MHz. HSPA+ 21Mbps data 2G 900, 1800, 1900 MHz.
Display	TFT 4.0", 480 x 800, Capacitive touch
Back camera	2.0MP rear with LED flash, 0.3MP front cameras
CPU and memory	1GHz dual core with 512MB RAM, 4GB with expandable external storage microSD(HC) [™] up to 32GB
Operating system	Android 4.4.2
Battery	Capacity 1200mAh Li-ion
	Charge Time 3-4 hrs with AC Charger
	Standby time 200 hours (subject to network)
	Voice talk time 5 hours (subject to network)
Connectivity	Bluetooth 3 Wi-Fi 802.11b/g/n 3.5mm jack
Supported file types	jpg, gif, png, amr, mid, mp3, mp4, 3gpp, h263

TROUBLESHOOTING

PLEASE CHECK THE MANUAL THOROUGHLY BEFORE CONTACTING YOUR SERVICE PROVIDER.

Symptom	Solution
How do I check the software version?	Menu > Settings > About phone > Build number
How do I reset to factory defaults?	Menu > Settings > Backup & reset > Factory data reset
How do I check the SMS service centre number?	Menu > Messages > Options > Settings > Text Message Settings (SMS)
How do I configure the MMS Settings?	Menu > Messages > Options > Settings > Multimedia Message (MMS)
How do I configure Email settings?	Apps > Email, or Menu > Settings > Accounts
How do I copy Contacts to or from my SIM card?	Contacts > Options > Import/Export > Follow the directions on screen

Symptom	Solution
How do I select Network mode?	Menu > Settings > More > Mobile Networks > Network Mode
How do I manually select a carrier?	Menu > Settings > More > Mobile Networks > Network operators > Search networks
How do I enable USB tethering?	Menu > Settings > More > Tethering and portable hotspot > USB tethering. (Connect as CDROM to install drivers)
How do I configure APN's	Menu > Settings > More > Mobile Networks > Access Point Names > Options > New APN
How do I enable Flight Mode?	Long press on the power key > Flight Mode
How do I clear my Browser?	Chrome > Options > Settings > Privacy > Clear Browsing Data
How do I check Call forwarding etc	Calls > Options > Settings > Voice Call > Call forwarding
How do I check for Software Updates?	Apps > System updates

Symptom	Solution
How do I get more technical support?	Visit ztemobiles.com.au or call 1300 789 475 during office hours AEST.
How do I change the Ringtone?	Menu > Settings > Sound > Phone Ringtone
The battery discharges quickly	Possible network coverage issue. Check the signal level. With only 1 or 2 bars, the battery has to work harder to maintain network contact. Limit multi-media to save power. The battery may be worn out.
The handset switches on by itself.	An alarm or calendar event switches the handset on automatically.
No incoming ring or alarm tone	Hold the power key to check the phone is not in silent mode. Check the ringtone and ring volume settings.

Symptom	Solution
I cannot charge the phone	Confirm the charger is properly inserted. Remove the battery, clean the contacts and check it is inserted correctly. The battery may be worn out. Tip: Charge the phone using the supplied USB cable.
The handset switches off after charging.	The handset is charging in the off state. Press and hold the power key to switch the handset ON.
I cannot connect to other Bluetooth devices	Turn Bluetooth on. Set visibility to Show. Make sure the pass-code is correct. Possible compatibility issues. Not all functionality is supported between different Bluetooth devices and standards.

ERROR MESSAGES

Message	Solution
No SIM Card	Check a valid SIM card is inserted. See the <i>Getting Started</i> section
Enter PIN code	You have set a SIM PIN. Please enter your SIM PIN code.
Enter PUK code	Contact your Service Provider to get the PUK code
Enter Unlock Code	Contact your Service Provider to obtain the network unlocking code.

WARRANTY INFORMATION

The warranty does not apply to defects or errors caused by:

- (a) Normal wear and tear, mishandling, physical damage, improper installation.
- (b) Water, exposure to solvents or any other liquid damage.
- (c) Any unauthorised disassembly, repair or modification.
- (d) Power surges, lightning, fire, flood or other natural events.
- (e) Use of the product with unauthorised third party products such as generic chargers.
- (f) Any other cause beyond the range of normal usage for products.

The End User shall have no right to reject, return, or receive a refund for any product under the above-mentioned situations. The End User's statutory rights are not excluded by these terms and conditions.

Note: Consult the warranty card for full information.

SAFETY

GENERAL STATEMENT ON RF ENERGY

The phone is a low-power radio transmitter and receiver. When switched on it intermittently transmits radio frequency (RF) energy (radio waves). The transmit power level is optimised for best performance and automatically reduces when there is good quality reception. Maximum power is only used at the edge of network coverage so under most circumstances the power output is very low. Under poor network conditions the phone transmits at a higher power, may get hot and have a shorter battery life.

SPECIFIC ABSORPTION RATE (SAR)

The phone is designed not to exceed the limits for exposure to radio waves recommended by the ICNIRP. The limits include safety margins designed to assure the protection of all persons, regardless of age and health.

The guidelines measure the Specific Absorption Rate, or SAR. The SAR limit for mobile devices is 2W/Kg. This device has been tested and approved to be lower than the maximum allowed SAR value and the result is published on <http://www.ztemobiles.com.au/T816.htm>

PRODUCT SAFETY INFORMATION



Please read all instructions before use



This device may produce bright or flashing lights



Do not use while driving



Do not dispose of in fire



Do not use while re-fuelling



Avoid contact with magnetic media



Small parts may be a choking hazard



Avoid Extreme Temperatures



This device may produce loud sounds



Avoid any contact with liquid, keep it dry



Keep away from pacemakers and other personal medical devices



Only use approved accessories



Obey warning signs in hospitals
and medical facilities



Do not attempt to
disassemble



Switch off when flying



Do not rely on this device
for emergency
communications



Switch off in explosive
environments

This device is certified by the Wi-Fi Alliance.



microSD™ is a trademark of SD Card Association